

**INTELLI**

*Series...*

NEW GEN WELDERS FOR NEW GEN STEELS

**ATS ELGI**™

THINK LONG RUN



# INTELLI SERIES WELDERS

NEW GEN WELDERS FOR NEW GEN STEELS

## About ATS ELGI

EMPOWERING THE  
AUTOMOTIVE SERVICE INDUSTRY  
FOR MORE THAN 6 DECADES

**ATS ELGI** is the largest manufacturer and distributor of Automotive Service Equipment in India. With our "One Stop Shop" approach, we offer the widest range of garage equipment in the country. Working closely with Authorised OEM workshops and Private Garages complements our profound understanding of the vehicle servicing business since **1960**.

**ATS ELGI** is a wholly owned subsidiary of **ELGI** Equipments Limited, a Global Player in the air compressor business.



LIFTING EQUIPMENT | BODY SHOP EQUIPMENT | WHEEL SERVICING EQUIPMENT | WASHING EQUIPMENT | LUBE EQUIPMENT  
DIAGNOSTIC EQUIPMENT | PNEUMATIC TOOLS | MOBILE SERVICE UNIT | SPECIAL PRODUCTS

# INTELLI

Series...

NEW GEN WELDERS FOR NEW GEN STEELS

## INVERTER SPOT 13500 FULLY AUTOMATIC



### Scope of supply



SPRING LOAD BALANCER KIT



C1 ARM L 95 mm



COOLANT & GREASE



### Technical Specification



2 %



0.95



400 V



16 A



12000 A



IP 20



50 - 60 Hz



5000 Hz



41 kW



79 x 45 x 90 cm



3 + 3 + 3 mm



400 dAN



8 kW



81 Kg



## Features

- Fully Automatic, Medium frequency, direct current (MFDC) inverter technology, microprocessor controlled resistance welding machine
- The innovative **SMART AUTOSET** technology, thanks to the automatic recognition of the materials and thickness, eliminates set-up times and guarantees optimal spot welding even if the types of steel are not known to operator
- The **WAVE** technology facilitates interaction with the machine and tracks all operating parameters for their processing and reporting
- The **POWER GUN** technology allows for high spot-welding currents with low absorption rates, the use of longer (5m) and lighter cables for a better holding and a wider range of action and minimum magnetic fields around the cables
- The multifunction digital panel can be used to select the automatic Smart Autoset mode as well as the EASY and the manual mode for customized welding applications

## Advantages

- Automatic recognition of the arm and inserted tool
- Pre- and post-heating for interventions on HSS and galvanized metals
- Monitoring of mains voltage
- Automatic cooling control of machine, clamp and cables
- Regulation of approach, slope, welding and holding times
- Regulation in pulsed welding
- Automatic/manual regulation of pressure between electrodes
- Complete with water-cooled pneumatic gun & Spring Load Balancer for Power Gun

## Optional Accessories - Arms



C ARM L 42 mm

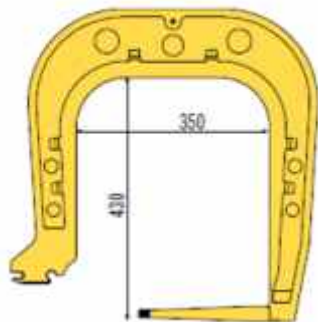

C ARM L 430 mm

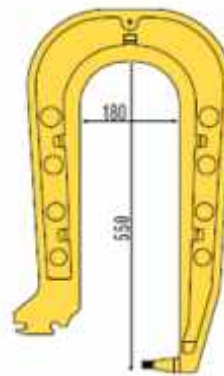

C ARM L 550 mm

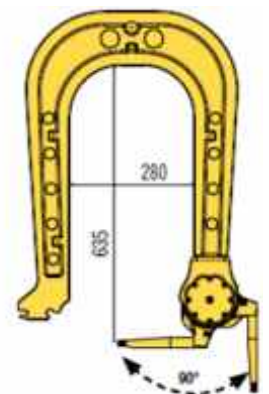

C ARM L 635mm

## Optional Accessories



Studder Kit



Caps Maintenance Kit



X Gun



WIFI Connectivity Kit

# INTELLI

Series....

NEW GEN WELDERS FOR NEW GEN STEELS

## SPOT 9000 SEMI AUTOMATIC



- Microprocessor controlled, electronic spot-welding machine suitable for use in the car body repair and industrial field.
- The digital, LCD, multifunction control panel allows the automatic regulation of spot welding parameters according to the chosen tool and sheet thickness.
- Digital Spotter is a work station that allows multiple interventions such as continuous and PULSE welding.

### Features

- Automatic identification of the tool
- Monitoring of mains voltage
- Automatic control of the GUM and cable cooling
- Choice of optimal spot-welding current according to mains power
- Visualization on a backlit LCD display of the set controls and parameters
- Equipped with air cooled pneumatic gun.

### Applications

PULSE single spot welding, spot welding of screws, washers, nails and rivets, spot welding/traction of special washers, intermittent welding, metal sheets warming and upsetting.



### Technical Specification



400 V



10 V



50 Hz



47 kW



7000 A



8 kW



0.8



IP22



3 + 3 mm



78 kg



3 %



79 X 45 X 90 cm

### Standard accessories



Studder Kit

# INTELLI

Series...

NEW GEN WELDERS FOR NEW GEN STEELS

Microprocessor controlled MIG / MAG / FLUX / BRAZING / MMA inverter wire welding machine

## MIG/MAG 240 INVERTER SYNERGIC



### Features

- The SYNERGIC adjustment of the welding parameters
- Great versatility in the use of various type of materials
- Thermostatic, over-voltage, under-voltage, motor generator (+/- 15%) protections
- Arc-force adjustment in MMA
- Euro torch connection
- Max Coil Size up to 300mm (15 kg)

### Advantages

- Low power consumption
- Light and compact
- Ease of use
- Long-pass welding



### Technical Specification

<b>V<sub>1PH</sub></b> = 230 V	<b>A<sub>MIN</sub> / A<sub>MAX</sub> DC</b> = 20 - 220 A	<b>A<sub>60% 40°C DC</sub></b> = 100 A	<b>A<sub>MAX</sub></b> = 32 A	<b>P<sub>MAX</sub></b> = 4.8 kW
<b>F</b> = 50 / 60 Hz	<b>ST</b> = 0.6 - 1 mm	<b>AL</b> = 0.8 - 1 mm	<b>BZ</b> = 0.8 - 1 mm	<b>W<sub>H</sub> / L</b> = 82.5 x 36 x 67 cm
<b>Ø<sub>DC</sub> MIN/MAX</b> = 1.6 - 3.2 mm	<b>SS</b> = 0.8 - 1 mm	<b>FX</b> = 0.8 - 1.2 mm	<b>IP</b> = IP 23	<b>kg</b> = 21 Kg

### Scope of supply



- Mt15 MIG Touch 3m (Red)
- TOLEDO 250 Work Clamp 250 A
- Cable TWO5V-A 1x025 1.80M PLUG ATLAS

### Optional accessories



Consumable Kit



Aluminum Kit



Electrode Holder

# INTELLI

Series....

NEW GEN WELDERS FOR NEW GEN STEELS

## PLASMA 40 INVERTER PLASMA CUTTER



- Inverter type compressed air plasma cutting system
- Contact striking of pilot arc
- Allows a rapid, distortion-proof cutting of all conductive materials

### Advantages

- 10 to 40 A Plasma Cutter
- 100% duty cycle at 20 A
- Torch automatic cooling
- Long lasting consumables for low running costs
- Compact weight and dimensions
- Warning LED for consumables change
- Thermostatic, over-voltage, under voltage, over-current protections
- Warning LED for torch under voltage, protections















CONTACT  
STRIKING



### Advantages

- More versatility and compatible
- Ease of use
- Fast cuts
- Precision cut quality

## Technical Specification

 230 V	 85 %	 16 A	 100 L/min	 55 X 14.5 X 24 cm
 10 - 40 A	 29 A	 0.7	 4 - 5 bar	 6.5 Kgs
 40 20% A	 4 kW	 15 mm	 IP 23	 50 Hz

**ATS ELGI**

**28**  
STATES

**65+**  
DEALERS

**60+**  
EXPERIENCE  
IN YEARS

**250+**  
NO. OF  
PRODUCTS

**130+**  
SALES  
WORK FORCE

**300+**  
SERVICE  
PERSONNEL

**8000+**  
CUSTOMERS

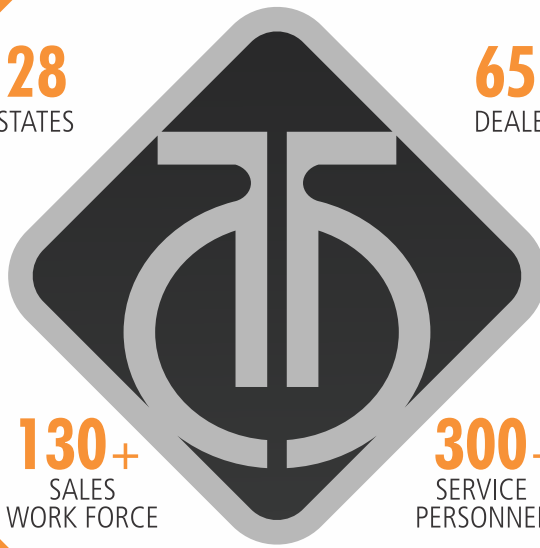

## ATS ELGI

Private Industrial Estate, Kurichy,  
Coimbatore - 641021, Tamil Nadu, India.

Visit us at : [www.ats-elgi.com](http://www.ats-elgi.com) | Email : [enquiry@ats-elgi.com](mailto:enquiry@ats-elgi.com)

Toll Free Number : **1800-203-3544**

Follow us on :     

ATS ELGI authorized dealer